

nickelodeon  
**TEENAGE MUTANT NINJA  
TURTLES**

79102

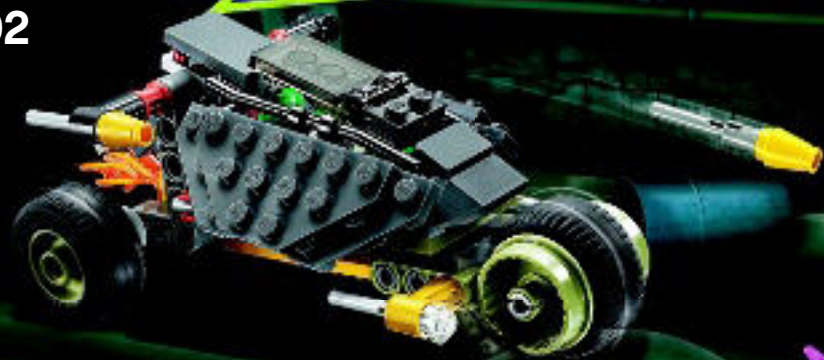

1



2



3



4





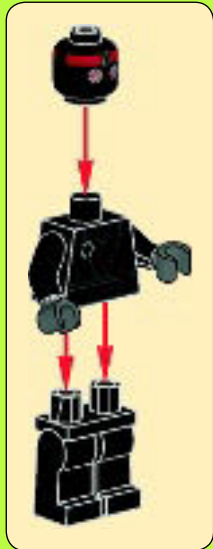
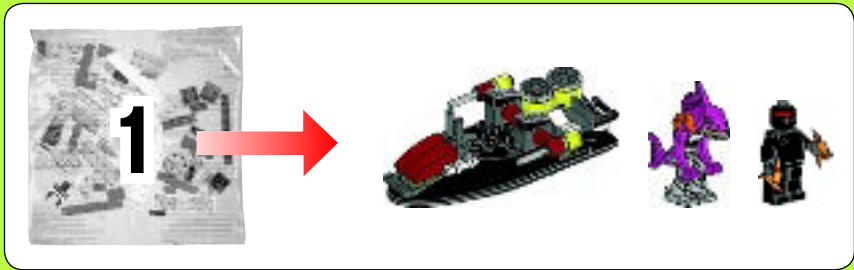

1



2





1

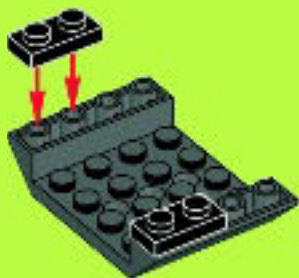

2





1x



1x

3

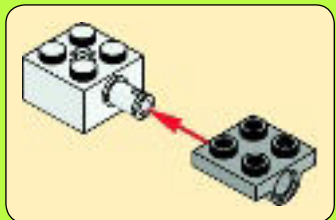

2x

4



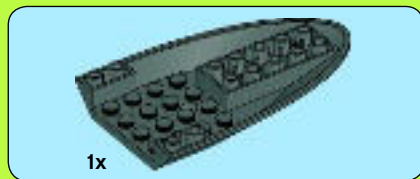

5

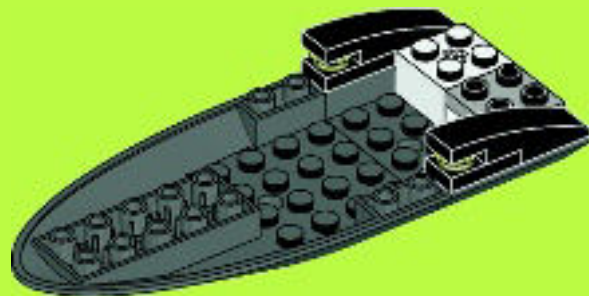

6

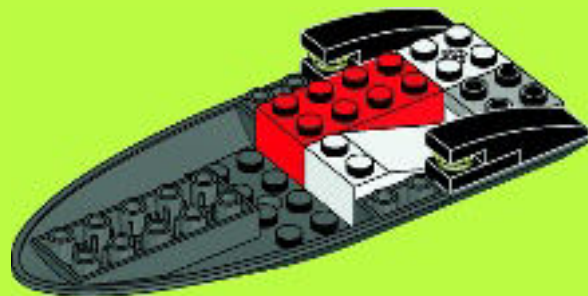



7

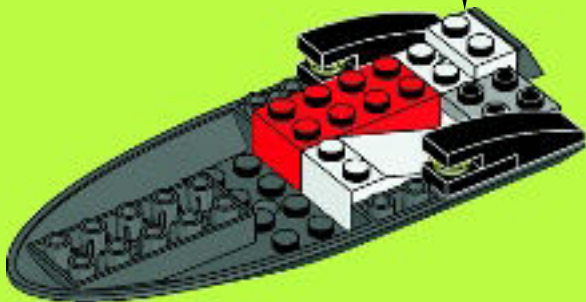
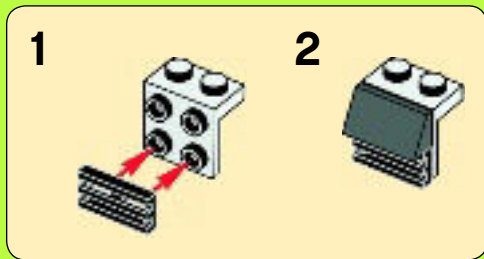

8

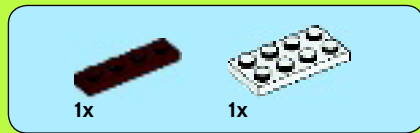

8

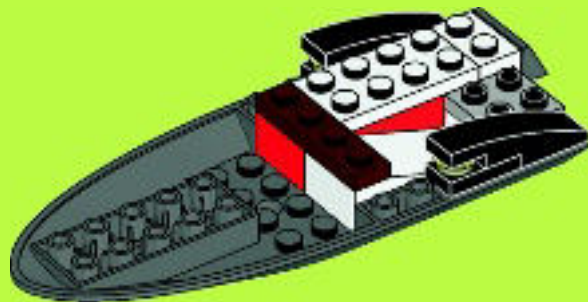



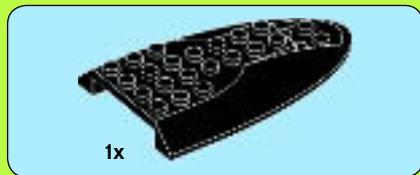

9



10

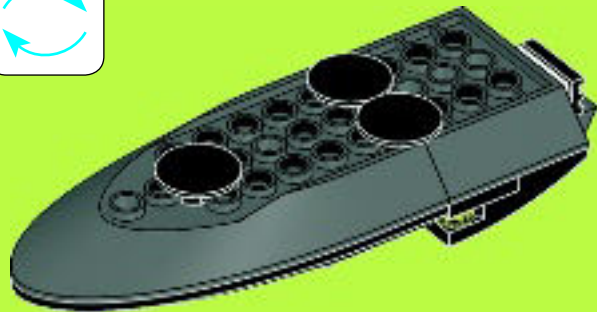



11

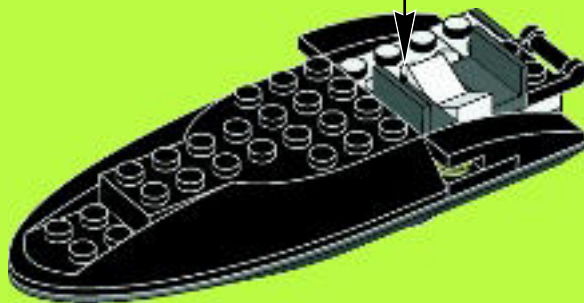
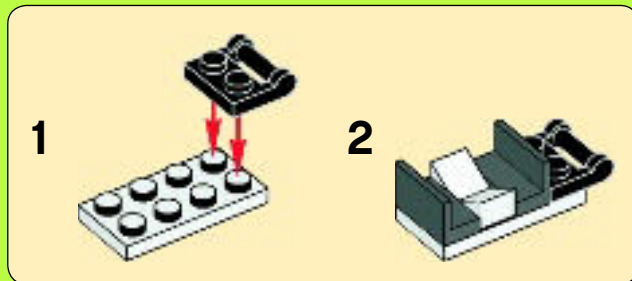

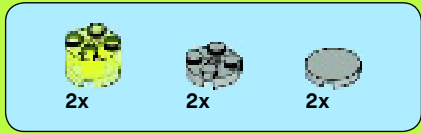

12

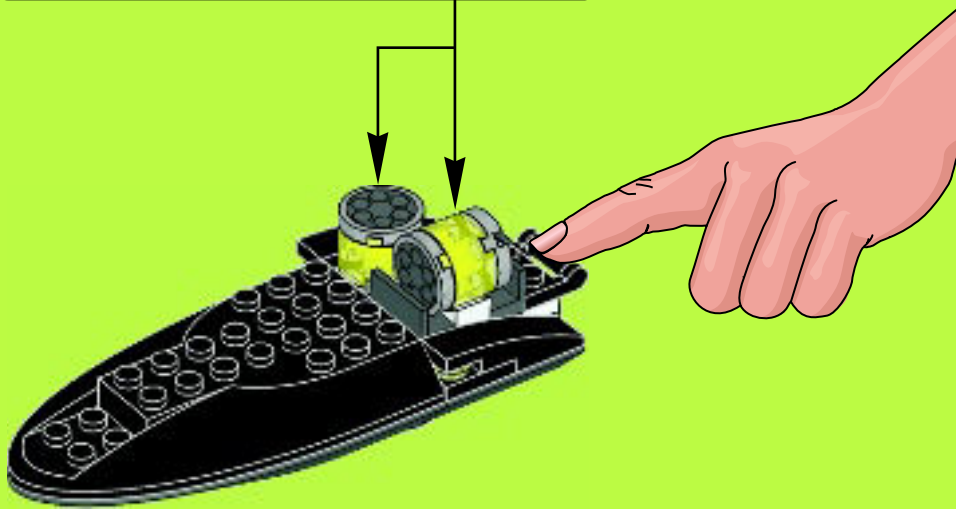

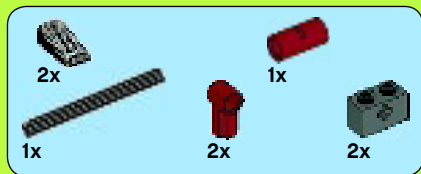

13

1



2

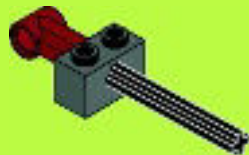

3

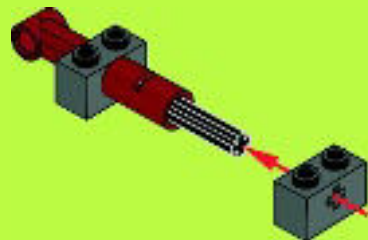

4

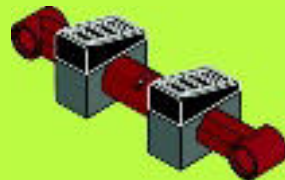



2x



2x

# 14

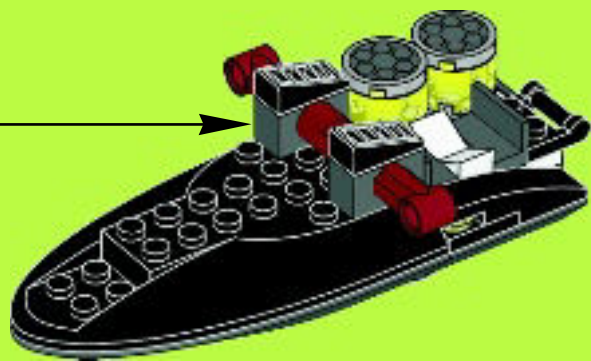



4x

# 15

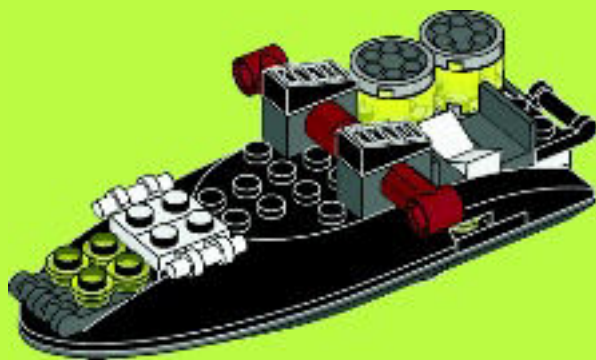

14



2x



2x

# 16

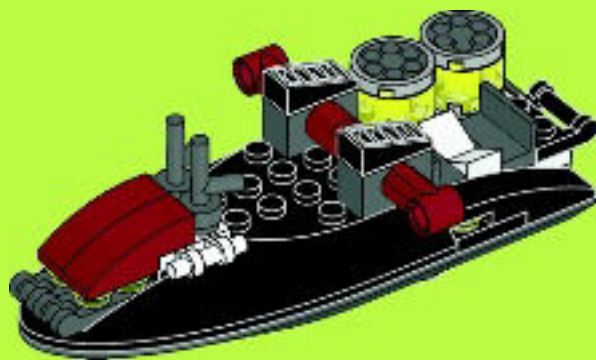



2x



2x

17

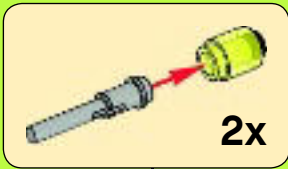

2x

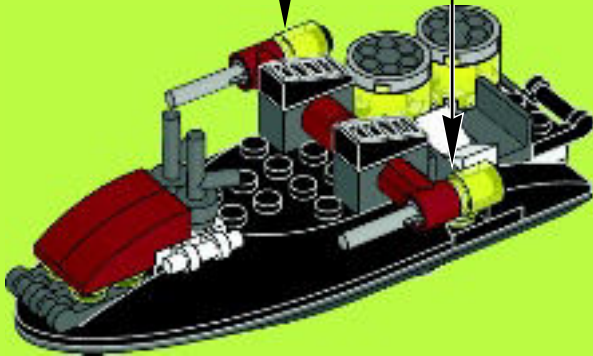

18

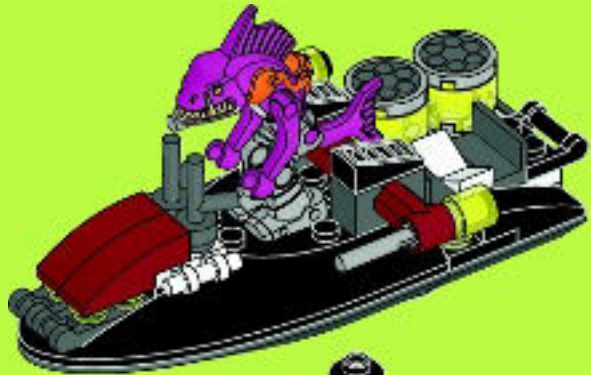

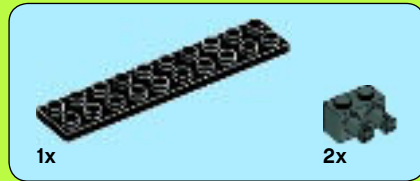
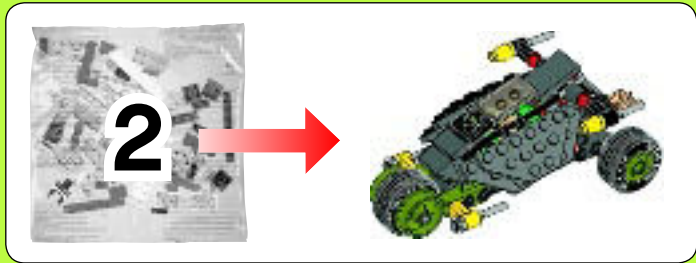

1

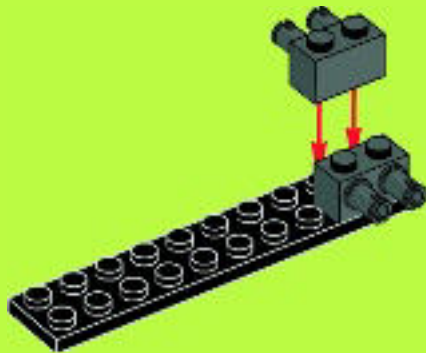
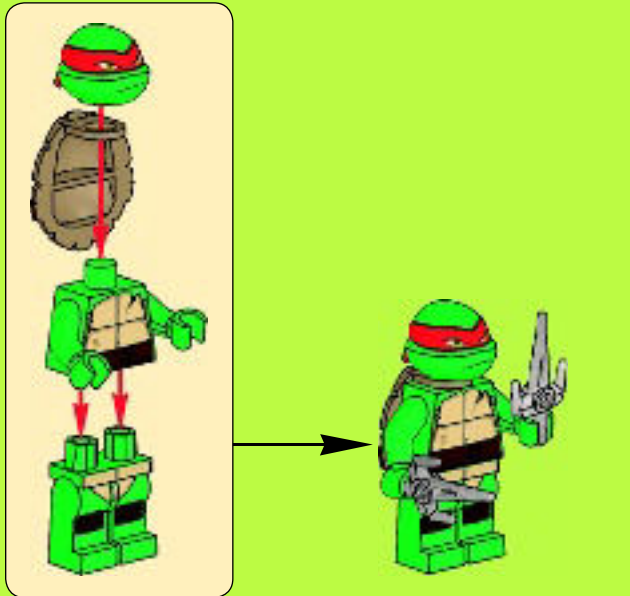





2

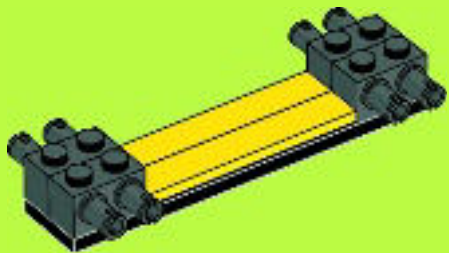

3

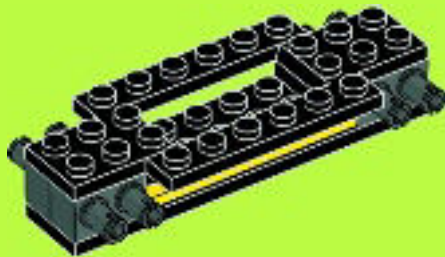



4

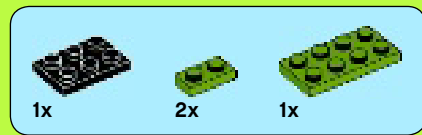
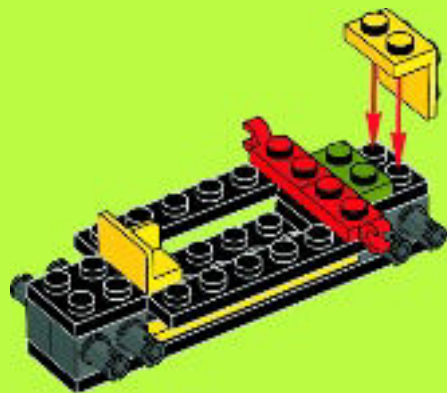

5

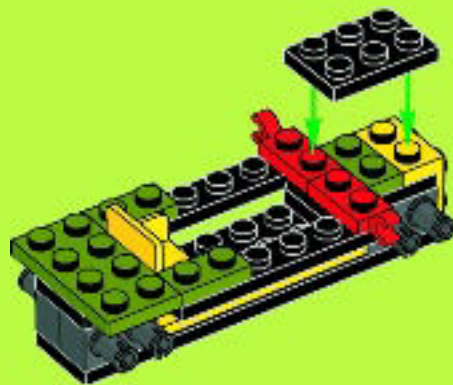



6



7

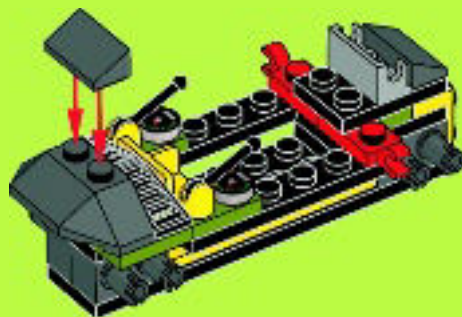



1x



1x

8

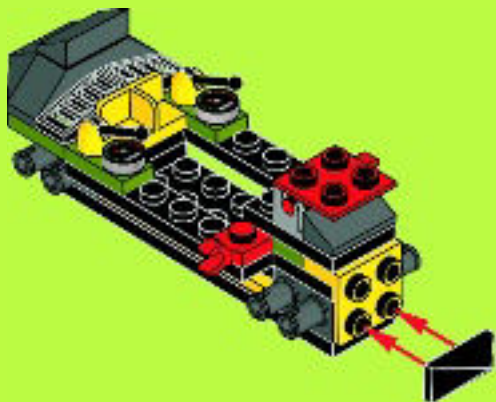

2x

9

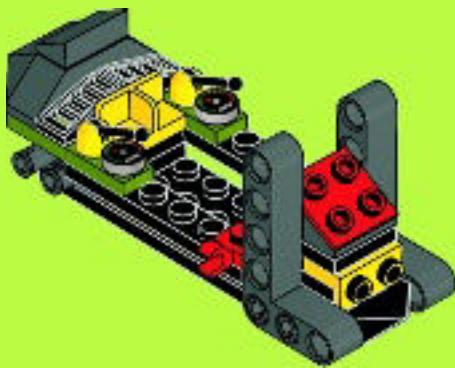

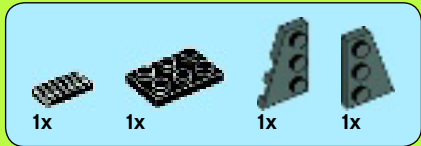

10

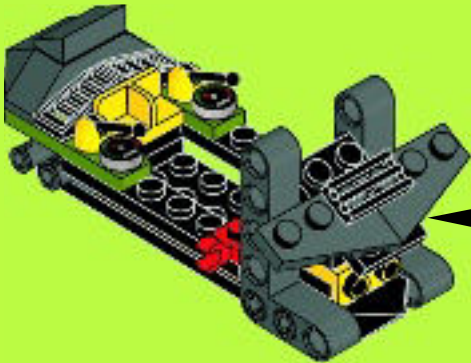

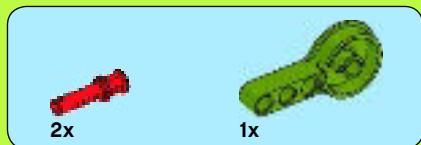

11

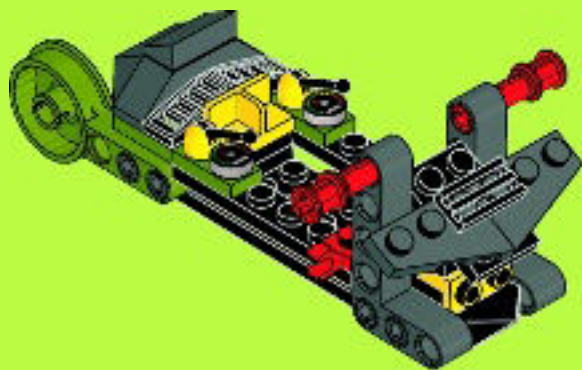

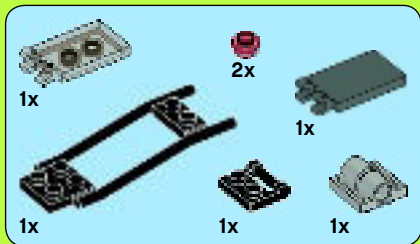

12

1



2



3

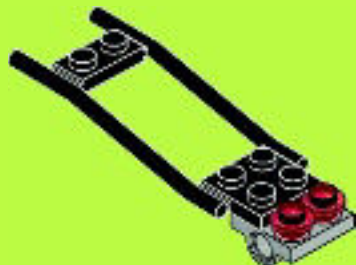

4

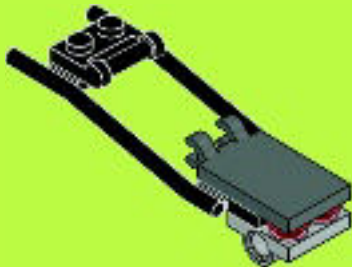

5

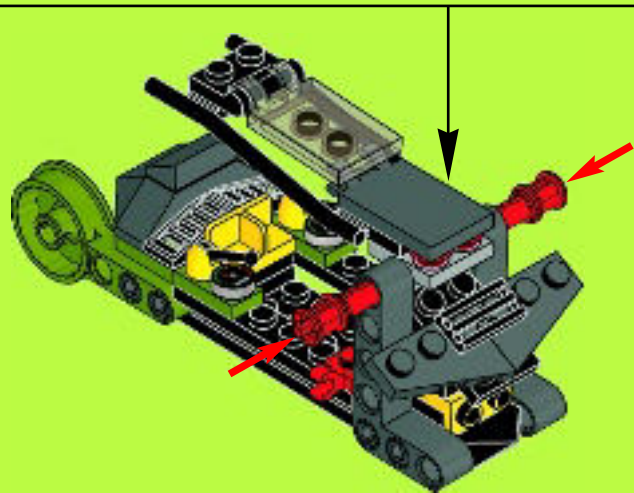
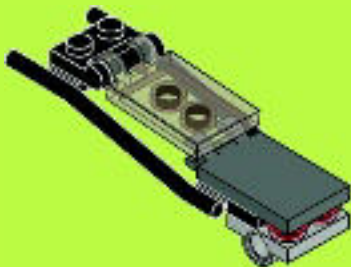





2x



2x

# 13

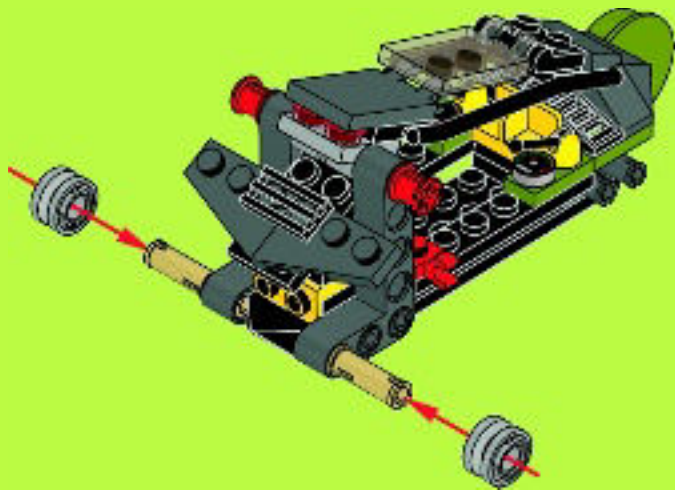



14

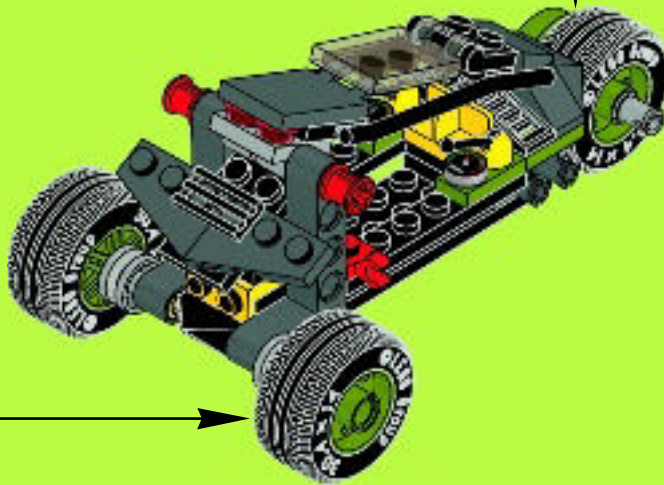
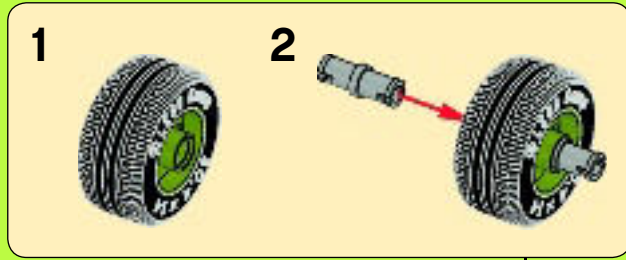



2x



1x

# 15

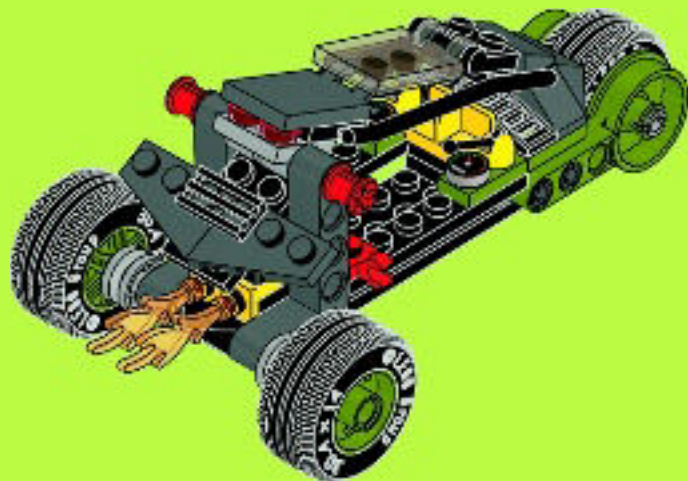



2x



2x



2x



2x

# 16

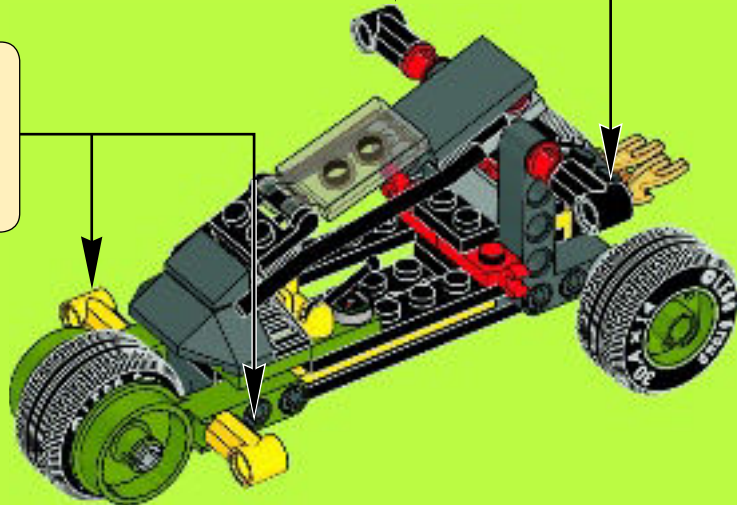
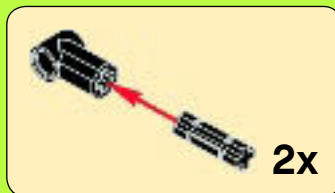
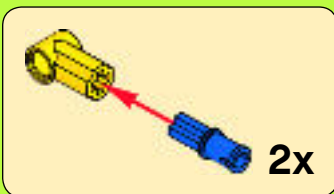



17

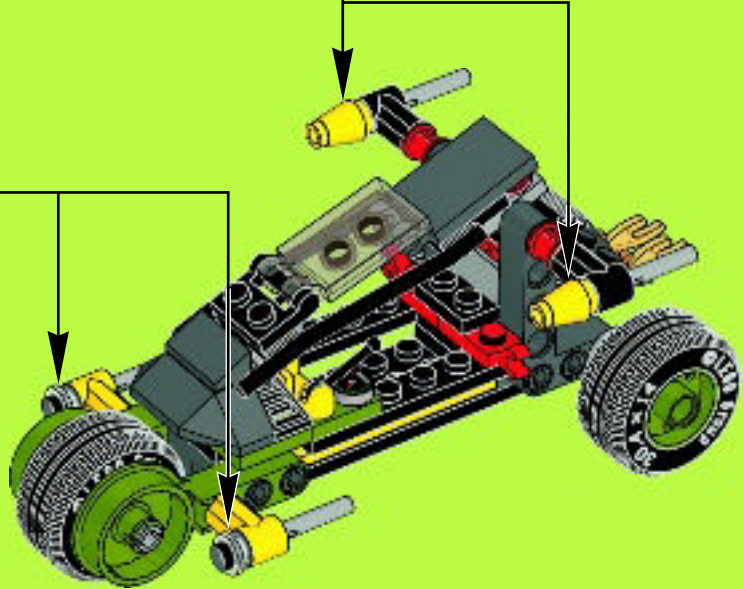
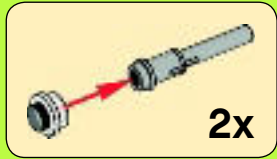
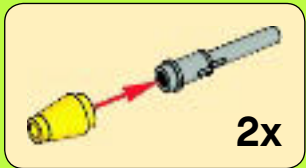

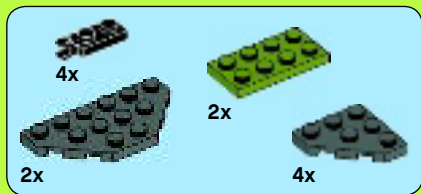

18

1



2



3

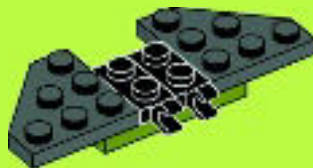

4

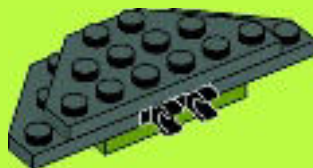

2x

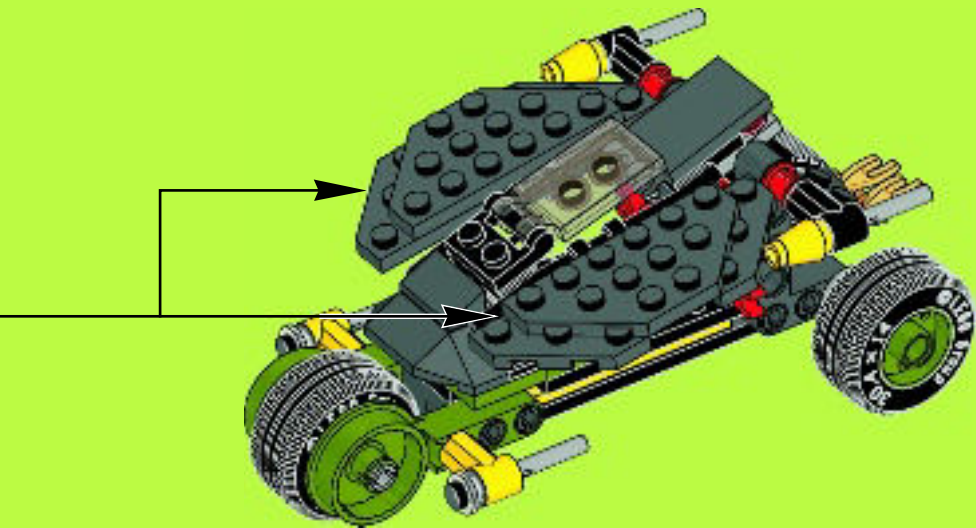

19

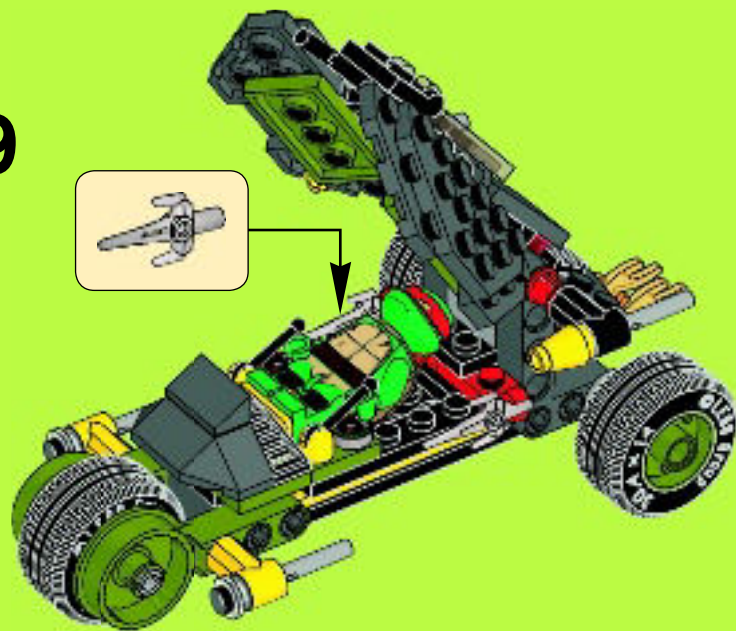





1x  
6023044



1x  
6030247



1x  
6025395



2x  
3005740



2x  
3005741



2x  
4107106



2x  
611649



6x  
3005749



1x  
6030356



2x  
4261397



2x  
4541546



2x  
4541306



1x  
4539091



1x  
4211190



1x  
6023060



2x  
4211480



2x  
4211376



2x  
4211475



2x  
6027628



1x  
4211469



6x  
4520320



2x  
4211758



2x  
4211807



2x  
6029860



1x  
6029853



2x  
4210935



4x  
4210697



3x  
4567887



1x  
6027686



2x  
4521187



1x  
4227517



1x  
4210869



1x  
4210872



4x  
4210897



2x  
4210984



2x  
4271950



2x  
4566028



2x  
4210753



1x  
4549999



1x  
4652483



3x  
6016483



3x  
6020144



3x  
6028102



2x  
6027698



4x  
4535739



2x  
241226



2x  
4225201



1x  
304826



2x  
6037746



3x  
4278359



1x  
9339



1x  
6030249



1x  
6022943



4x  
4541191



2x  
4107085



2x  
4109810



1x  
370626



2x  
302126



2x  
302326



3x  
4550937



1x  
6027996



1x  
383226



1x  
4656764



1x  
4623524



2x  
4514554



1x  
4143137



1x  
4143000



2x  
302001



2x  
4504369



1x  
4615649



2x  
4140583



1x  
300121



2x  
4534648



1x  
613421



2x  
4140806



2x  
4206482



2x  
4525464



1x  
4615642



2x  
663624



1x  
4621603



2x  
74156



2x  
4107066



2x  
6030333



2x  
4646867



2x  
4600519



**Customer Service**

**Kundenservice**

**Service Consommateurs**

**Servicio Al Consumidor**

**LEGO.com/service or dial**



**00800 5346 5555 :**



**1-800-422-5346 :**





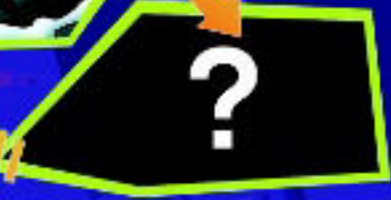

[LEGO.COM/TURTLES](http://LEGO.COM/TURTLES)

79104



79101



79100



79105



79103



79102





79100



79100



79100



79101



79101



79101



79102



79102



79102



79103



79103



79103



79103



79103



79104



79104



79104



79104



79104



79105



79105



79105



79105



3



[www.LEGOclub.com/Max](http://www.LEGOclub.com/Max)

**LEGO club**<sup>TM</sup>

**FREE\*! GRATIS! GRATUIT!**

\*Paid subscription in Australia and New Zealand.  
\*Abonnement payant en Australie et Nouvelle-Zélande.

©2013 The LEGO Group.



# WIN!

Go to [www.LEGOsurvey.com/product](http://www.LEGOsurvey.com/product) to fill out a survey for a chance to win a cool LEGO® Product!

No purchase necessary.

Open to all residents where not prohibited.



## [www.LEGOsurvey.com/product](http://www.LEGOsurvey.com/product)

### GEWINNE!

Nimm an der Umfrage auf [www.LEGOsurvey.com/product](http://www.LEGOsurvey.com/product) teil und hab die Chance ein cooles LEGO® Produkt zu gewinnen!

Die Teilnahme am Gewinnspiel führt zu keinerlei Kaufverpflichtungen. Teilnahme in allen nicht ausgeschlossenen Ländern möglich.

6036587

### WIN!

Ga naar [www.LEGOsurvey.com/product](http://www.LEGOsurvey.com/product), vul een enquêteformulier in en maak kans op een cool LEGO® product.

Geen aankoopverplichting. Iedereen mag deelnemen, uitgezonderd ingezetenden van landen waar een enquêteverbod geldt.

### GAGNE!

Visite [www.LEGOsurvey.com/product](http://www.LEGOsurvey.com/product) pour répondre à un questionnaire et avoir une chance de gagner un produit LEGO® très cool!

Aucune obligation d'achat. Ouvert à tous les résidents des pays autorisés.

### 当てよう!

[www.LEGOsurvey.com/product](http://www.LEGOsurvey.com/product) にアクセスして、アンケートにご記入ください。当選者にはレゴ®製品を差し上げます。

お買い上げの必要はありません。

禁止されていない限り、すべての皆様にご利用いただけます。



LEGO.com

LEGO and the LEGO logo are trademarks of the LEGO Group. ©2013 The LEGO Group.

©2013 Viacom Overseas Holdings C.V. All Rights Reserved. Teenage Mutant Ninja Turtles and all related titles, logos and characters are trademarks of Viacom Overseas Holdings C.V.